

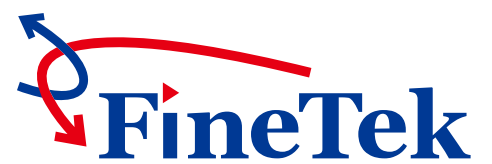

## Microprocessor Bargraphic Display Scaling Meter



[www.fine-tek.com](http://www.fine-tek.com)





# NON-LINEAR TANK VOLUME CONVERSION FEATURE

## NON-LINEAR TANK VOLUME CONVERSION FEATURE

PM/PB Series support volume adjustment function for non-linear tanks. By means of a 20-point look-up table, panel meter calculate tank volume according to the material level measured.



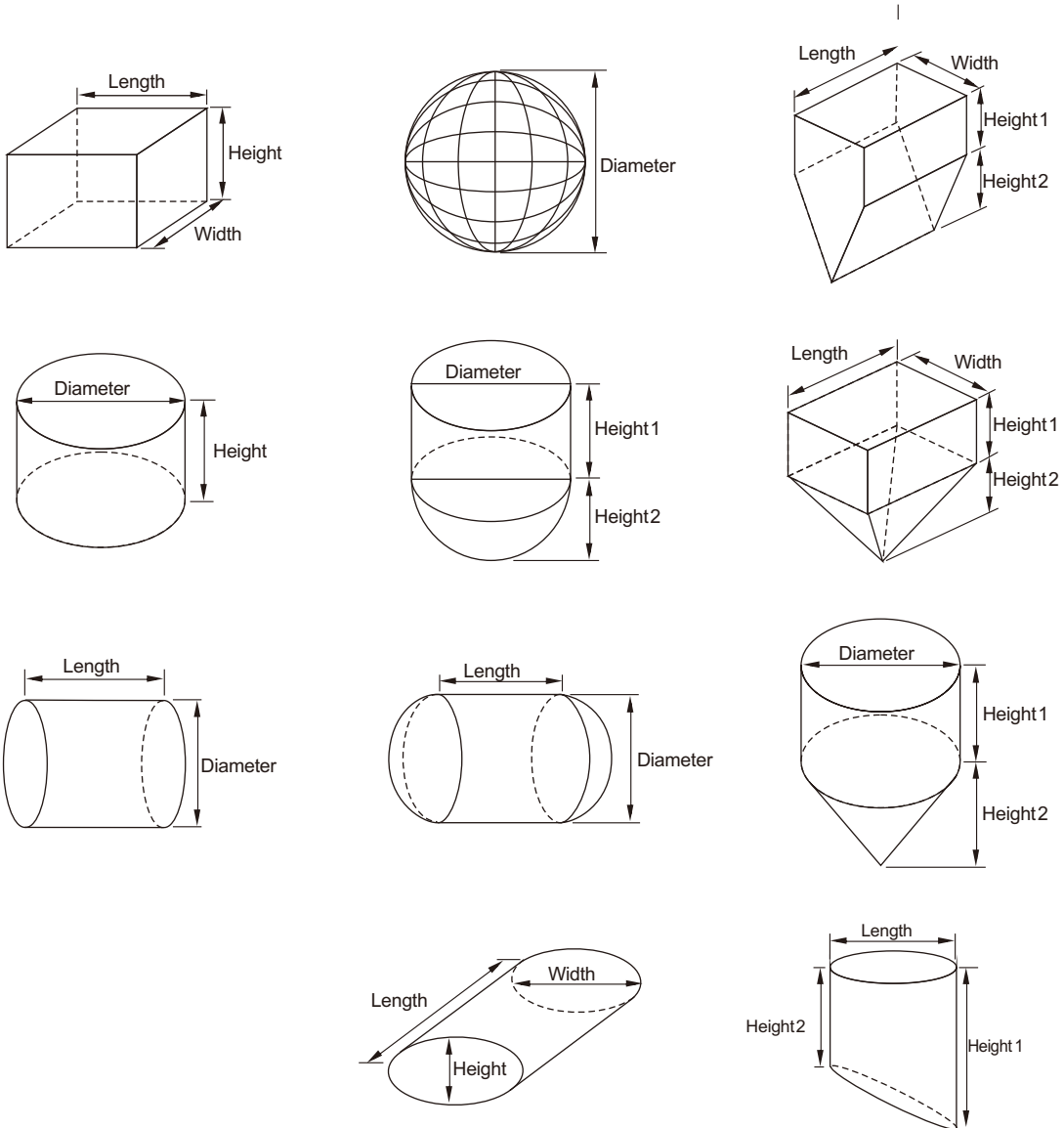

Bundled with this package, a software is provided, user simply select tank type shown as below, and enter necessary dimension, tank volume and 20 control points will be calculated and reported.

### TANK TYPE:







# SPECIFICATIONS

## Microprocessor Bargraph Display Panel Meter

Appearance					
Dimension (mm)		DIN 3/16 48 (W) x144 (H) x121.5 (D)	DIN 3/16 48 (W) x144 (H) x121.5 (D)	DIN 3/16 144 (W) x48 (H) x121.5 (D)	DIN 3/16 144 (W) x48 (H) x121.5 (D)
Model		PB-2471	PB-1471	PB-1470	PB-1570
Display		Dual Row, 4-Digit, 7 Segment LED Dual Column, 101 Segment LED (bargraph) 8 Relay Setpoints Max. - LED	4 Digits 7-Segment LED 101 LED Bargraph Display Totally 6 Set Points	4-Digit, 7 Segment LED 101 Segment LED (bargraph) 6 Relay Setpoints Max. - LED	5-Digit, 7 Segment LED 101 Segment LED (bargraph) 6 Relay Setpoints Max.- LED
Standard	Display Range	-1999 ~ +9999	-1999 ~ +9999	-1999 ~ +9999	-19999 ~ +32767
	Input signal	Refer to Input Signal Selection in Order Information (Page 5)	Refer to Input Signal Selection in Order Information (Page 6)	Refer to Input Signal Selection in Order Information (Page 7)	Refer to Input Signal Selection in Order Information (Page 8)
	Relay contact	Up to 4 Relays (as standard),SPST (N.O. or N.C. Jumper Selectable), 3A@250VAC/5A@30VDC	Up to 4 Relays (as standard),SPST (N.O. or N.C. Jumper Selectable), 3A@250VAC/5A@30VDC	Up to 4 Relays (as standard),SPST (N.O. or N.C. Jumper Selectable), 3A@250VAC/5A@30VDC	Up to 4 Relays (as standard),SPST (N.O. or N.C. Jumper Selectable), 3A@250VAC/5A@30VDC
	Power supply	85~265VAC or 18~36VDC	85~265VAC or 18~36VDC	85~265VAC or 18~36VDC	85~265VAC or 18~36VDC
Optional	Relay	Expand to 8 Relay	Expand to 6 Relay	Expand to 6 Relay	Expand to 6 Relay
	Analog output	0/4~20mA or 0~10VDC	0/4~20mA or 0~10VDC	0/4~20mA or 0~10VDC	0/4~20mA or 0~10VDC
	Communication port	RS485 MODBUS	RS485 MODBUS	RS485 MODBUS	RS485 MODBUS
	Non-Linear Function	20-Point Linearization for Non-Linear Tanks	20-Point Linearization for Non-Linear Tanks	20-Point Linearization for Non-Linear Tanks	20-Point Linearization for Non-Linear Tanks

# SPECIFICATIONS

## Microprocessor Digit Display Panel Meter

Appearance					 
Dimension (mm)		DIN 1/8 96 (W) x48 (H) x128.5 (D)	DIN 1/8 96 (W) x48 (H) x128.5 (D)	DIN 1/8 96 (W) x48 (H) x128.5(D)	DIN 1/8 96 (W) x48 (H) x128.5(D)
Model		PM-1430	PM-2430	PM-1530	PM-1430-W (4 digit) PM-1530-W (5 digit)
Display		Display 4-Digit, 7 Segment LED 4 Relay Setpoints Max. - LED	Dual, 4-Digit, 7 Segment LED 4 Relay Setpoints Max. - LED	5-Digit, 7 Segment LED 4 Relay Setpoints Max. - LED	4 or 5-Digit, 7 Segment LED 4 Relay Setpoints Max.- LED
Standard	Display range	-1999 ~ +9999	-1999 ~ +9999	-19999 ~ +32767	-1999 ~ +9999 -19999 ~ +99999
	Input signal	Refer to Input Signal Selection in Order Information (Page 5)	Refer to Input Signal Selection in Order Information (Page 6)	Refer to Input Signal Selection in Order Information (Page 7)	Refer to Input Signal Selection in Order Information (Page 8)
	Relay contact	Up to 2 Relays (as standard), SPST (N.O. or N.C. Jumper Selectable), 3A@250VAC /5A@30VDC	Up to 4 Relays (as standard), SPST (N.O. or N.C. Jumper Selectable), 3A@250VAC /5A@30VDC	Up to 2 Relays (as standard), SPST (N.O. or N.C. Jumper Selectable), 3A@250VAC/5A@30VDC	Up to 4 Relays (as standard), SPST (N.O. or N.C. Jumper Selectable), 3A@250VAC /5A@30VDC
Optional	Power supply	85~265VAC or 18~36VDC	85~265VAC or 18~36VDC	85~265VAC or 18~36VDC	85~265VAC or 18~36VDC
	Relay	Expand Up to 4 Relays Max.	Expand Up to 6 Relays Max.	Expand Up to 4 Relays Max.	Not Expandable (4 Relays Max.)
	Analog output	0/4~20mA or 0~10VDC	0/4~20mA or 0~10VDC	0/4~20mA or 0~10VDC	0/4~20mA or 0~10VDC
	Communication port	RS485 MODBUS	RS485 MODBUS	RS485 MODBUS	RS485 MODBUS
Non-Linear Function		20-Point Linearization for Non-Linear Tanks	20-Point Linearization for Non-Linear Tanks	20-Point Linearization for Non-Linear Tanks	20-Point Linearization for Non-Linear Tanks

# PB-2471 Microprocessor Bargraph Display Panel Meter



## FEATURES:

- Dual 4 Digits LED Numeric Display
- Dual 101-segment LED Bargraph display
- Wide Range of User Definable Scaling Ratio
- Modulized input signal boards available for different applications
- Optional Output Boards with Isolated Analog Output & Relay Output
- 85V~265VAC or 18~36VDC Switching Power Supply
- Support volume adjustment function for non-linear tanks (optional)

## SPECIFICATIONS

Dimension (mm)	48 (W) x144 (H) x121.5 (D) DIN 3/16
Model	PB-2471
Power supply	85 ~ 265V AC or 18~36V DC Switching Power Supply
Power supply for sensor	DC24V, 50mA
Display	Dual 4 Digits, 0.36" 7-Segment LED Display 101 LED Bargraph Display 4 LED set-point indicator Display Range: -1999 ~ +9999 Over Range Display: "1" or "-1"
Input signal	Range: Refer to Ordering information Accuracy: 0.1%FS or $\pm 1$ digit Temperature coefficient: 200ppm/ $^{\circ}$ C ADC Resolution: 4-1/2 digit Sampling Rate: 2 samples/second/channel
Relay contact	4 relay (up to 8 relay) 3A/250V AC or 5A/30V DC (N.C. / N.O. Jumper selectable)
Analog output	4~20mA, 0~20mA, 2~10V and 0~10V (optional)
Power consumption	Less than 12VA
Communication port	RS485 (optional) Modbus Protocol
Operating condition	0~50 $^{\circ}$ C(20 to 90% RH non-condensed)
Storage condition	0~70 $^{\circ}$ C(20 to 90% RH non-condensed)

## TERMINAL

### ARRANGEMENTS:

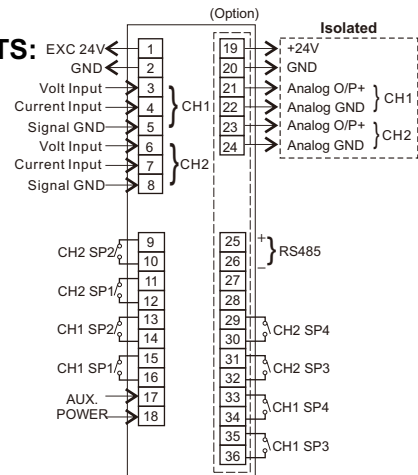

## EXTERIOR/CUTOUT DIMENSIONS (Unit:mm)

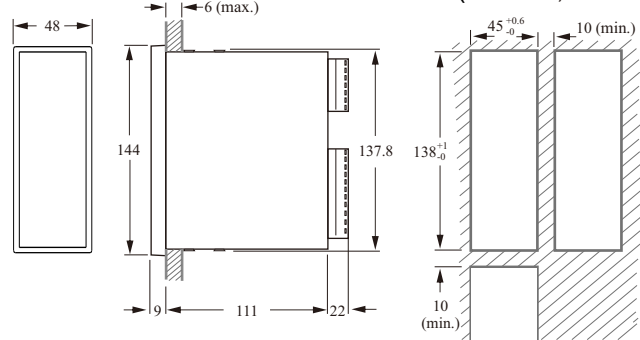

## ORDERING INFORMATION:

PB-2471-□□□□-□□□□

Power supply	S---85~265V AC T---18~36V DC
Input signal (CH1)	1---4~20mA DC with Exc 24V 2---0~20 mA DC with Exc 24V 3---0~200 mA DC with Exc 24V 4---5V DC with Exc 24V 5---10V DC with Exc 24V 6---20V DC with Exc 24V 7---200V DC with Exc 24V
Input signal (CH2)	1---4~20mA DC with Exc 24V 2---0~20 mA DC with Exc 24V 3---0~200 mA DC with Exc 24V 4---5V DC with Exc 24V 5---10V DC with Exc 24V 6---20V DC with Exc 24V 7---200V DC with Exc 24V
Relay contact	0---0 Relays 2---2 Relays 4---4 Relays 8---8 Relays
Non-Linear function	0---Without (Standard) 1---Support 20 points Vessel Conversion
Analog output	0---Without 5---Dual Analog output, 0~10V 6---Dual Analog output, 0/4~20mA
Communication port	0---Without 1---Support RS485 interface

**Ex:** PB-2471-S14-4000

Represents: PB-2471 Model, Power supply 85~265V AC, Analog input signal, CH1: 4~20mA, CH2: 0~5V, 4 relay contact, without Non-Linear Function, without Analog output.

# PB-1471 Microprocessor Bargraph Display Panel Meter



## FEATURES:

- 4 Digits LED Numeric Display
- 101-segment LED Bargraph display
- Wide Range of User Definable Scaling Ratio
- Modulized input signal boards available for different applications
- Optional Output Boards with Isolated Analog Output & Relay Output
- 85V~265VAC or 18~36VDC Switching Power Supply
- Support volume adjustment function for non-linear tanks (optional)

## SPECIFICATIONS

Dimension (mm) **48 (W) x144 (H) x121.5 (D) DIN 3/16**

Model **PB-1471**

Power SUPply **85 ~ 265V AC or 18~36V DC  
Switching Power Supply**

Power supply for sensor **DC24V, 50mA**

Display **4 Digits, 0.36" 7-Segment red LED  
Display**

Display **101 LED Bargraph Display  
6 LED set-point indicator  
Display Range: -1999 ~ +9999  
Over Range Display: "1" or "-1"**

Input signal **Range: Refer to Ordering information  
Accuracy: 0.1%FS or  $\pm 1$  digit  
Temperature coefficient: 200ppm/ $^{\circ}$ C  
ADC Resolution: 4-1/2 digit  
Sampling Rate:  
4 samples/second/channel**

Relay contact **4 relay (up to 6 relay)  
3A/250V AC or 5A/30V DC  
(N.C. / N.O. Jumper selectable)**

Analog output **4~20mA, 0~20mA, 2~10V and 0~10V (optional)**

Power consumption **Less than 9VA**

Communication port **RS485 (optional) Modbus Protocol**

Operating condition **0~50 $^{\circ}$ C(20 to 90% RH non-condensed)**

Storage condition **0~70 $^{\circ}$ C(20 to 90% RH non-condensed)**

## TERMINAL

### ARRANGEMENTS:

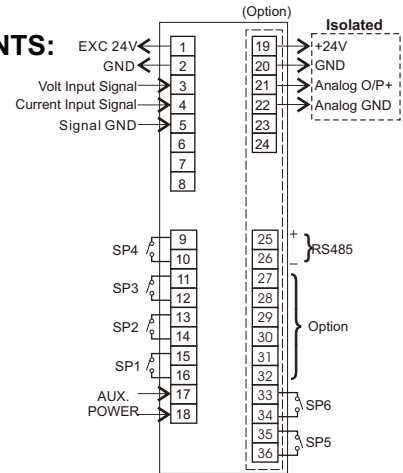

## EXTERIOR/CUTOUT DIMENSIONS

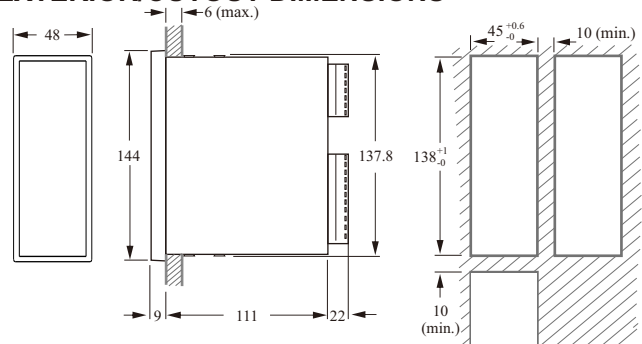

## ORDERING INFORMATION:

**PB-1471-□□□□-□□□□**

Power supply	S---85~265V AC T---18~36V DC
Input signal	01---4~20mA DC with Exc 24V 02---0~20 mA DC with Exc 24V 03---0~200 mA DC with Exc 24V 04---5V DC with Exc 24V 05---10V DC with Exc 24V 06---20V DC with Exc 24V 07---200V DC with Exc 24V  A1---2mA AC RMS A2---20mA AC RMS A3---200mA AC RMS A4---1A AC RMS A5---5A AC RMS  B1---100mV AC RMS B2---200mV AC RMS B3---2V AC RMS B4---20V AC RMS B5---200V AC RMS B6---600V AC RMS  C1--- $\pm 2$ mA DC with Exc 24V C2--- $\pm 20$ mA DC with Exc 24V C3--- $\pm 200$ mA DC with Exc 24V C4--- $\pm 1$ Amp DC C5--- $\pm 5$ Amp DC  D1--- $\pm 20$ mV DC with Exc 24V D2--- $\pm 50$ mV DC with Exc 24V D3--- $\pm 100$ mV DC with Exc 24V D4--- $\pm 200$ mV DC with Exc 24V
Relay contact	0---0 Relays 2---2 Relays 4---4 Relays 6---6 Relays
Non-Linear function	0---Without (Standard) 1---Support 20 points Vessel Conversion
Analog output	0---Without 1---0~10V Analog Output 2---0/4~20mA Analog Output
Communication port	0---Without 1---Support RS485 interface

**EX:** PB-1471-S01-4101

Represents: PB-1471 Model, Power supply 85~265V AC, Analog input signal 4~20mA, 4 relay contact, Support Non-Linear Function, without Analog output, Support RS485 interface.

# PB-1470 Microprocessor Bargraph Display Panel Meter



## FEATURES:

- 4 Digits LED Numeric Display
- 101-segment LED Bargraph display
- Wide Range of User Definable Scaling Ratio
- Modulized input signal boards available for different applications
- Optional Output Boards with Isolated Analog Output & Relay Output
- 85V~265VAC or 18~36VDC Switching Power Supply
- Support volume adjustment function for non-linear tanks (optional)

## SPECIFICATIONS

Dimension (mm) **144 (W) x48 (H) x121.5 (D) DIN 3/16**

Model **PB-1470**

Power supply 85 ~ 265V AC or 18~36V DC  
Switching Power Supply

Power supply for sensor DC24V, 50mA

Display 4 Digits, 0.56" 7-Segment red LED Display  
101 LED Bargraph Display  
6 LED set-point indicator  
Display Range: -1999 ~ +9999  
Over Range Display: "1" or "-1"

Input signal Range: Refer to Ordering information  
Accuracy: 0.1%FS or  $\pm 1$  digit  
Temperature coefficient: 200ppm/ $^{\circ}$ C  
ADC Resolution: 4-1/2 digit  
Sampling Rate:  
4 samples/second/channel

Relay contact 4 relay (up to 6 relay)  
3A/250V AC or 5A/30V DC  
(N.C. / N.O. Jumper selectable)

Analog output 4~20mA, 0~20mA, 2~10V and 0~10V (optional)

Power consumption Less than 9VA

Communication port RS485 (optional) Modbus Protocol

Operating condition 0~50 $^{\circ}$ C(20 to 90% RH non-condensed)

Storage condition 0~70 $^{\circ}$ C(20 to 90% RH non-condensed)

## TERMINAL ARRANGEMENTS:

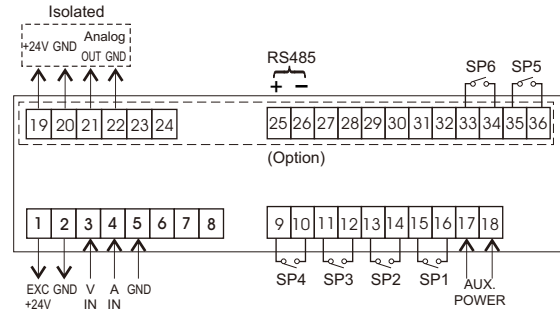

## EXTERIOR/CUTOUT DIMENSIONS

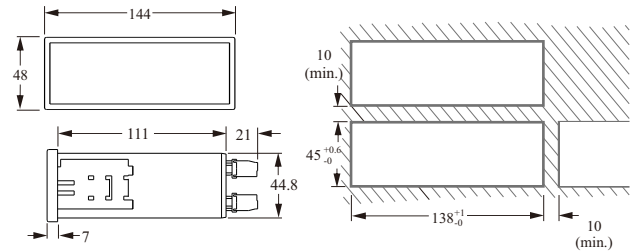

## ORDERING INFORMATION:

PB-1470-□ □ □ □ □ □ □ □

Power supply	S---85~265V AC T---18~36V DC
Input signal	01---4~20mA DC with Exc 24V 02---0~20 mA DC with Exc 24V 03---0~200 mA DC with Exc 24V 04---5V DC with Exc 24V 05---10V DC with Exc 24V 06---20V DC with Exc 24V 07---200V DC with Exc 24V  A1---2mA AC RMS A2---20mA AC RMS A3---200mA AC RMS A4---1A AC RMS A5---5A AC RMS  B1---100mV AC RMS B2---200mV AC RMS B3---2V AC RMS B4---20V AC RMS B5---200V AC RMS B6---600V AC RMS  C1--- $\pm 2$ mA DC with Exc 24V C2--- $\pm 20$ mA DC with Exc 24V C3--- $\pm 200$ mA DC with Exc 24V C4--- $\pm 1$ Amp DC C5--- $\pm 5$ Amp DC  D1--- $\pm 20$ mV DC with Exc 24V D2--- $\pm 50$ mV DC with Exc 24V D3--- $\pm 100$ mV DC with Exc 24V D4--- $\pm 200$ mV DC with Exc 24V
Relay contact	0---0 Relays 2---2 Relays 4---4 Relays 6---6 Relays
Non-Linear function	0---Without (Standard) 1---Support 20 points Vessel Conversion
Analog output	0---Without 1---0~10V Analog Output 2---0/4~20mA
Communication port	0---Without 1---Support RS485 interface

**EX:** PB-1470-S01-4101

Represents: PB-1470 Model, Power supply 85~265V AC, Analog input signal 4~20mA, 4 relay contact, Support Non-Linear Function, without Analog output, Support RS485 interface.

# PB-1570 Microprocessor Bargraph Display Panel Meter



## FEATURES:

- 5 Digits LED Numeric Display
- 101-segment LED Bargraph display
- Wide Range of User Definable Scaling Ratio
- Modulized input signal boards available for different applications
- Optional Output Boards with Isolated Analog Output & Relay Output
- 85V~265VAC or 18~36VDC Switching Power Supply
- Support volume adjustment function for non-linear tanks (optional)

## SPECIFICATIONS

Dimension (mm) **144 (W) x48 (H) x121.5 (D) DIN 3/16**

Model **PB-1570**

Power supply 85 ~ 265V AC or 18~36V DC  
Switching Power Supply

Power supply for sensor DC24V, 50mA

Display 5 Digits, 0.56" 7-Segment red LED Display  
101 LED Bargraph Display  
6 LED set-point indicator  
Display Range: -19999 ~ +32767  
Over Range Display: "1" or "-1"

Input signal Range: Refer to Ordering information  
Accuracy: 0.1%FS or  $\pm 1$  digit  
Temperature coefficient: 200ppm/ $^{\circ}$ C  
ADC Resolution: 4-1/2 digit  
Sampling Rate:  
4 samples/second/channel

Relay contact 4 relay (up to 6 relay)  
3A/250V AC or 5A/30V DC  
(N.C. / N.O. Jumper selectable)

Analog output 4~20mA, 0~20mA, 2~10V and 0~10V (optional)

Power consumption Less than 9VA

Communication port RS485 (optional) Modbus Protocol

Operating condition 0~50 $^{\circ}$ C(20 to 90% RH non-condensed)

Storage condition 0~70 $^{\circ}$ C(20 to 90% RH non-condensed)

## TERMINAL ARRANGEMENTS:

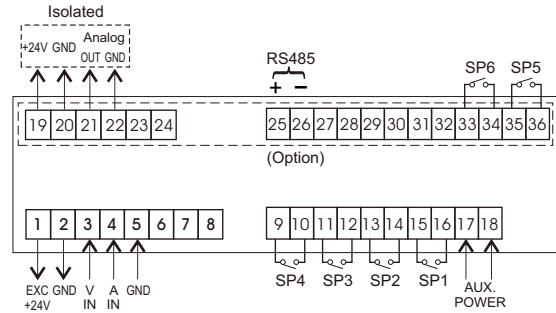

## EXTERIOR/CUTOUT DIMENSIONS

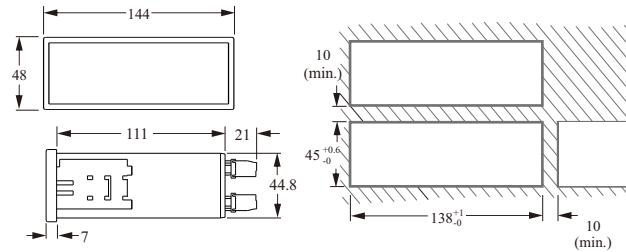

## ORDERING INFORMATION:

PB-1570-□□□-□□□□□

Power Supply	S---85~265V AC T---18~36V DC								
Input Signal	01---4~20mA DC with Exc 24V 02---0~20 mA DC with Exc 24V 03---0~200 mA DC with Exc 24V 04---5V DC with Exc 24V 05---10V DC with Exc 24V 06---20V DC with Exc 24V 07---200V DC with Exc 24V								
Relay Contact	A1---2mA AC RMS A2---20mA AC RMS A3---200mA AC RMS A4---1A AC RMS A5---5A AC RMS	C1--- $\pm 2$ mA DC with Exc 24V C2--- $\pm 20$ mA DC with Exc 24V C3--- $\pm 200$ mA DC with Exc 24V C4--- $\pm 1$ Amp DC C5--- $\pm 5$ Amp DC							
Non-Linear Function	B1---100mV AC RMS B2---200mV AC RMS B3---2V AC RMS B4---20V AC RMS B5---200V AC RMS B6---600V AC RMS	D1--- $\pm 20$ mV DC with Exc 24V D2--- $\pm 50$ mV DC with Exc 24V D3--- $\pm 100$ mV DC with Exc 24V D4--- $\pm 200$ mV DC with Exc 24V							
Analog output	0---Without 1---0~10V Analog Output 2---0/4~20mA								
Communication port	0---Without 1---Support RS485 interface								

EX: PB-1570-S01-4101

Represents: PB-1570 Model, Power supply 85~265V AC, Analog input signal 4~20mA, 4 relay contact, Support Non-Linear Function, without Analog output, Support RS485 interface.

# PM-1430 Microprocessor Digit Display Panel Meter



## FEATURES:

- 4 Digits LED Numeric Display
- Wide Range of User Definable Scaling Ratio
- Modulized input signal boards available for different applications
- Optional Output Boards with Isolated Analog Output & Relay Output
- 85V~265VAC or 18~36VDC Switching Power Supply
- Support volume adjustment function for non-linear tanks (optional)
- IP54 Class front panel

## SPECIFICATIONS

Dimension (mm) **96 (W) x48 (H) x128.5 (D) DIN 1/8**

Model **PM-1430**

Power supply **85 ~ 265V AC or 18~36V DC**  
Switching Power Supply

Power supply for sensor **DC24V, 50mA**

Display **4 Digits, 0.56" 7-Segment red LED Display**

Display **4 LED set-point indicator**  
Display Range: **-1999 ~ +9999**  
Over Range Display: **"1" or "-1"**

Input signal **Range: Refer to Ordering information**  
**Accuracy: 0.1%FS or ± 1 digit**  
**Temperature coefficient: 200ppm/°C**  
**ADC Resolution: 4-1/2 digit**  
**Sampling Rate:**  
**4 samples/second/channel**

Relay contact **2 or 4 relay**  
**3A/250V AC or 5A/30V DC**  
**(N.C. / N.O. Jumper selectable)**

Analog output **4~20mA, 0~20mA, 2~10V and 0~10V (optional)**

Power consumption **Less than 7VA**

Communication port **RS485 (optional) Modbus Protocol**

Operating condition **0~50°C(20 to 90% RH non-condensed)**

Storage condition **0~70°C(20 to 90% RH non-condensed)**

## TERMINAL ARRANGEMENTS:

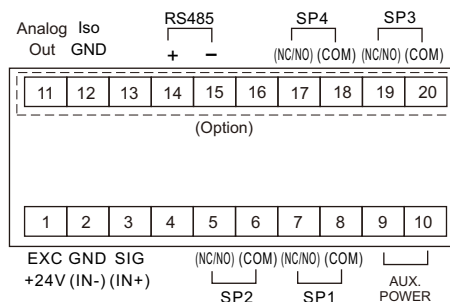

## EXTERIOR/CUTOUT DIMENSIONS

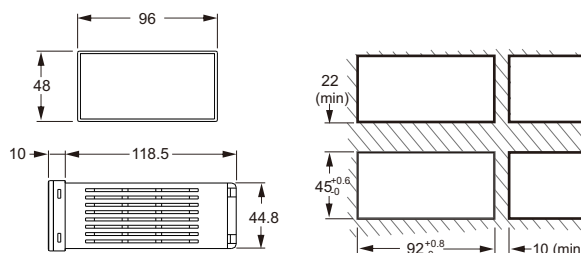

## ORDERING INFORMATION:

**PM-1430-□□□□-□□□□**

Power supply	S---85~265V AC T---18~36V DC
Input signal	01---4~20mA DC with Exc 24V 02---0~20 mA DC with Exc 24V 03---0~200 mA DC with Exc 24V 04---5V DC with Exc 24V 05---10V DC with Exc 24V 06---20V DC with Exc 24V 07---200V DC with Exc 24V  A1---2mA AC RMS A2---20mA AC RMS A3---200mA AC RMS A4---1A AC RMS A5---5A AC RMS  C1---± 2 mA DC with Exc 24V C2---± 20 mA DC with Exc 24V C3---± 200 mA DC with Exc 24V C4---± 1Amp DC C5---± 5Amp DC  B1---100mV AC RMS B2---200mV AC RMS B3---2V AC RMS B4---20V AC RMS B5---200V AC RMS B6---600V AC RMS  D1---± 20mV DC with Exc 24V D2---± 50mV DC with Exc 24V D3---± 100mV DC with Exc 24V D4---± 200mV DC with Exc 24V
Relay contact	0---0 Relays 2---2 Relays 4---4 Relays
Non-Linear function	0---Without (Standard) 1---Support 20 points Vessel Conversion
Analog output	0---Without 1---0~10V Analog Output 2---0/4~20mA
Communication port	0---Without 1---Support RS485 interface

**EX: PM-1430-S01-4101**

Represents: PM-1430 Model, Power supply 85~265V AC, Analog input signal 4~20mA, 4 relay contact, Support Non-Linear Function, without Analog output, Support RS485 interface.

# PM-2430 Microprocessor Digit Display Panel Meter



## FEATURES:

- Dual Channel Signal Input
- Dual 4 Digits LED Numeric Display
- Wide Range of User Definable Scaling Ratio
- Modulized input signal boards available for different applications
- Optional Output Boards with Isolated Analog Output & Relay Output
- 85V~265VAC or 18~36VDC Switching Power Supply
- Support volume adjustment function for non-linear tanks (optional)
- IP54 Class front panel

## SPECIFICATIONS

Dimension (mm)	<b>96 (W) x48 (H) x128.5 (D) DIN 1/8</b>
Model	<b>PM-2430</b>
Power supply	85 ~ 265V AC or 18~36V DC Switching Power Supply
Power supply for sensor	DC24V, 50mA
Display	CH1: 4 Digits, 0.36" 7-Segment red LED CH2: 4 Digits, 0.36" 7-Segment green LED 4 LED set-point indicator Display Range: -1999 ~ +9999 Over Range Display: "1" or "-1"
Input signal	Range: Refer to Ordering information Accuracy: 0.1%FS or $\pm 1$ digit Temperature coefficient: 200ppm/ $^{\circ}$ C ADC Resolution: 4-1/2 digit Sampling Rate: 2 samples/second/channel
Relay contact	4 relay 3A/250V AC or 5A/30V DC (N.C. / N.O. Jumper selectable)
Analog output	4~20mA, 0~20mA, 2~10V and 0~10V (optional)
Power consumption	Less than 7VA
Communication port	RS485 (optional) Modbus Protocol
Operating condition	0~50 $^{\circ}$ C(20 to 90% RH non-condensed)
Storage condition	0~70 $^{\circ}$ C(20 to 90% RH non-condensed)

## TERMINAL ARRANGEMENTS:

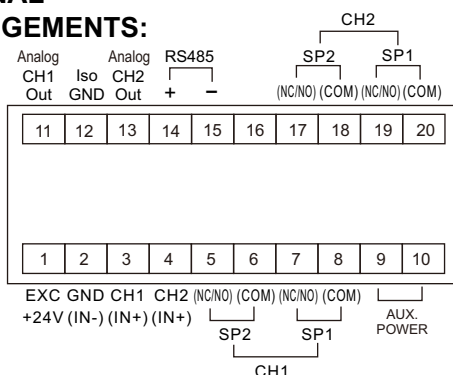

## EXTERIOR/CUTOUT DIMENSIONS

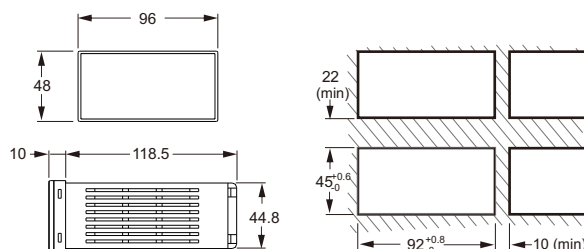

## ORDERING INFORMATION:

**PM-2430-□□□□□□□□**

Power supply	S---85~265V AC T---18~36V DC
Input signal (CH1)	1---4~20mA DC with Exc 24V 2---0~20 mA DC with Exc 24V 3---0~200 mA DC with Exc 24V 4---5V DC with Exc 24V 5---10V DC with Exc 24V 6---20V DC with Exc 24V 7---200V DC with Exc 24V
Input signal (CH2)	1---4~20mA DC with Exc 24V 2---0~20 mA DC with Exc 24V 3---0~200 mA DC with Exc 24V 4---5V DC with Exc 24V 5---10V DC with Exc 24V 6---20V DC with Exc 24V 7---200V DC with Exc 24V
Relay contact	0---0 Relays 2---2 Relays 4---4 Relays 6---6 Relays
Non-Linear function	0---Without (Standard) 1---Support 20 points Vessel Conversion
Analog output	0---Without 5---Dual Analog Output 0~10V 6---Dual Analog Output 0/4~20mA
Communication port	0---Without 1---Support RS485 interface

**EX:** PM-2430-S14-4000

Represents: PM-2430 Model, Power supply 85~265V AC, Analog input signal CH1: 4~20mA , CH2: 0~5V, 4 relay contact, without Non-Linear Function, without Analog output.

# PM-1530 Microprocessor Digit Display Panel Meter



## FEATURES:

- 5 Digits LED Numeric Display
- Wide Range of User Definable Scaling Ratio
- Modulized input signal boards available for different applications
- Optional Output Boards with Isolated Analog Output & Relay Output
- 85V~265VAC or 18~36VDC Switching Power Supply
- Support volume adjustment function for non-linear tanks (optional)
- IP54 Class front panel

## SPECIFICATIONS

Dimension (mm) **96 (W) x48 (H) x128.5 (D) DIN 1/8**

Model **PM-1530**

Power supply 20~250 Vac / Vdc 50/60Hz

Display 5 Digits, 0.56" 7-Segment red LED Display  
4 LED set-point indicator  
Display Range: -19999 ~ +32767  
Over Range Display: "1" or "-1"

Input signal Range: Refer to Ordering information  
Accuracy: 0.1%FS or  $\pm 1$  digit  
Temperature coefficient: 200ppm/ $^{\circ}$ C  
ADC Resolution: 4-1/2 digit  
Sampling Rate:  
24 samples/second/channel

Relay contact 2 or 4 relay  
3A/250V AC or 5A/30V DC  
(N.C. / N.O. Jumper selectable)

Analog output 4~20mA, 0~20mA, 2~10V and 0~10V (optional)

Power consumption Less than 7VA

Communication port RS485 (optional) Modbus Protocol

Operating condition 0~50 $^{\circ}$ C(20 to 90% RH non-condensed)

Storage condition 0~70 $^{\circ}$ C(20 to 90% RH non-condensed)

## TERMINAL ARRANGEMENTS:

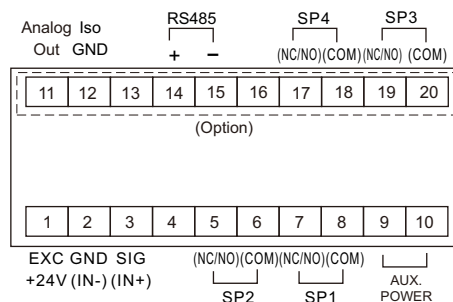

## EXTERIOR/CUTOUT DIMENSIONS

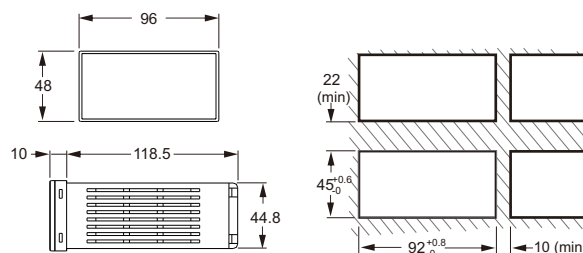

## ORDERING INFORMATION:

PM-1530-□□□□□□□□

Power Supply	S---85~265V AC T---18~36V DC	▲	□	□	□	□	□	□
Input signal	01---4~20mA DC with Exc 24V 02---0~20 mA DC with Exc 24V 03---0~200 mA DC with Exc 24V 04---5V DC with Exc 24V 05---10V DC with Exc 24V 06---20V DC with Exc 24V 07---200V DC with Exc 24V  A1---2mA AC RMS A2---20mA AC RMS A3---200mA AC RMS A4---1A AC RMS A5---5A AC RMS  B1---100mV AC RMS B2---200mV AC RMS B3---2V AC RMS B4---20V AC RMS B5---200V AC RMS B6---600V AC RMS  C1--- $\pm 2$ mA DC with Exc 24V C2--- $\pm 20$ mA DC with Exc 24V C3--- $\pm 200$ mA DC with Exc 24V C4--- $\pm 1$ Amp DC C5--- $\pm 5$ Amp DC  D1--- $\pm 20$ mV DC with Exc 24V D2--- $\pm 50$ mV DC with Exc 24V D3--- $\pm 100$ mV DC with Exc 24V D4--- $\pm 200$ mV DC with Exc 24V	▲	▲	▲	▲	▲	▲	
Relay contact	0---0 Relays 2---2 Relays 4---4 Relays	▲	▲	▲	▲	▲	▲	
Non-Linear function	0---Without (Standard) 1---Support 20 points Vessel Conversion	▲	▲	▲	▲	▲	▲	
Analog output	0---Without 1---0~10V Analog Output 2---0/4~20mA	▲	▲	▲	▲	▲	▲	
Communication port	0---Without 1---Support RS485 interface	▲	▲	▲	▲	▲	▲	

**EX:** PM-1530-S01-4101

Represents: PM-1530 Model, Power supply 85~265V AC, Analog input signal 4~20mA, 4 relay contact, Support Non-Linear Function, without Analog output, Support RS485 interface.

# PM-1X30-W Microprocessor Digit Display Panel Meter



## FEATURES:

- 5 Digits LED Numeric Display
- Wide Range of User Definable Scaling Ratio
- Modulized input signal boards available for different applications
- Optional Output Boards with Isolated Analog Output & Relay Output
- 20~250Vac/Vdc 50/60Hz Switching Power Supply
- Support volume adjustment function for non-linear tanks (optional)
- IP54 Class front panel

## SPECIFICATIONS

Dimension (mm) **96 (W) x48 (H) x128.5 (D) DIN 1/8**

Model **PM-1□30-W**

Power supply 20~250 Vac / Vdc 50/60Hz

Power supply for sensor

Display 5 Digits, 0.56" 7-Segment red LED Display  
4 LED set-point indicator  
Display Range: -19999 ~ +99999  
Over Range Display: "1" or "-1"

Input signal Range: Refer to Ordering information  
Accuracy: 0.1%FS or ± 1 digit  
Temperature coefficient: 200ppm/°C  
ADC Resolution: 4-1/2 digit  
Sampling Rate: 24 samples/second/channel

Relay contact 4 relay  
3A/250V AC or 5A/30V DC

Analog output 4~20mA, 0~20mA, 2~10V and 0~10V (optional)

Power consumption Less than 7VA

Communication port RS485 (optional) Modbus Protocol

Operating condition 0~50°C(20 to 90% RH non-condensed)

Storage condition 0~70°C(20 to 90% RH non-condensed)

## TERMINAL ARRANGEMENTS:

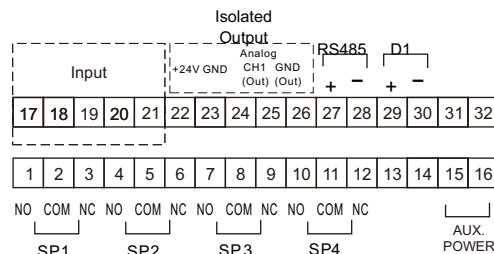

## EXTERIOR/CUTOUT DIMENSIONS

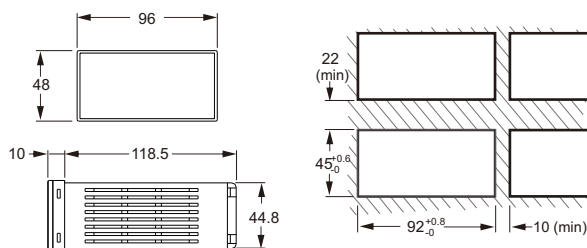

## ORDERING INFORMATION:

PM-1□30-W □□-□□□□□□

Display	4 : 4 digit 5 : 5 digit
Power supply	20~250 Vac-dc, 50~60Hz
Input signal	01---4~20mA DC with Exc 24V 02---0~20 mA DC with Exc 24V 03---0~200 mA DC with Exc 24V 04---0~5V DC with Exc 24V 05---0~10V DC with Exc 24V 06---0~20V DC with Exc 24V 07---0~200V DC with Exc 24V A1---0~2mA AC RMS A2---0~20mA AC RMS A3---0~200mA AC RMS A4---0~1A AC RMS A5---0~5A AC RMS C1---0~±2 mA DC with Exc 24V C2---0~±20 mA DC with Exc 24V C3---0~±200 mA DC with Exc 24V C4---0~±1Amp DC C5---0~±5Amp DC B1---0~100mV AC RMS B2---0~200mV AC RMS B3---0~2V AC RMS B4---0~20V AC RMS B5---0~200V AC RMS B6---0~600V AC RMS B7---0~1000V AC RMS D1---0~±20mV DC with Exc 24V D2---0~±50mV DC with Exc 24V D3---0~±100mV DC with Exc 24V D4---0~±200mV DC with Exc 24V E1---5/10/20/50/100/200mV/ V DC (Option) with Exc 24V E2---1/2/5/10/20mV/V DC (Option) with ISO 10V E3---1/2/10/20/40mV/V DC (Option) with ISO 5V F1---TC(K · J · E · N · T) & RTD (PT100 · JPT100) F2---TC(K · J · R · S · B · E · N · T) & RTD (PT100 · JPT100)
Relay contact	0-4:0-4 Relays
Non-Linear function	0---Without (Standard) 1---Support 20 points Vessel Conversion
Analog output	0---Without 1---0~10V Analog Output 2---0/4~20mA
Communication port	0---Without 1---Support RS485 interface
Digital input	0 : Without 1 : DI

EX: PM-1530-S01-41011

Represents: PM-1530 Model, Power supply 85~265V AC, Analog input signal 4~20mA, 4 relay contact, Support Non-Linear Function, without Analog output, Support RS485 interface.

# PB DC SIGNAL INPUT MODULE

This section will elaborate how to adapt to different input signals in the PB series panel meter, by using the correct jumper and using iSEL command. Panel meter series can accommodate 6 types of conventional input signals, 20mA, 200mA, 5V, 10V, 20V, 200V, please refer below for setup.

## Dual Channel Signal Input Module: (for PB-2471)

11: 4~20mA DC with Excitation +24V

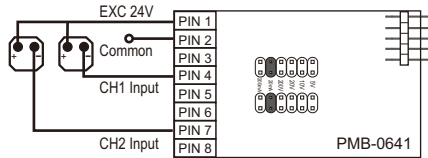

22: 0~20mA DC with Excitation +24V

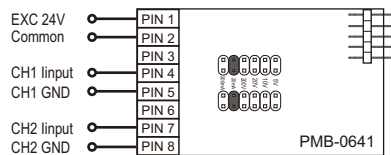

33: 0~200mA DC with Excitation +24V

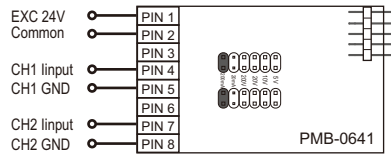

44: ±5V DC with Excitation +24V

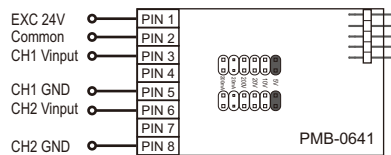

55: ±10V DC with Excitation +24V

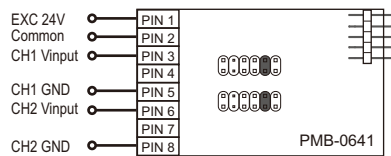

66: ±20V DC with Excitation +24V

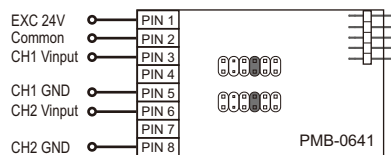

77: ±200V DC with Excitation +24V

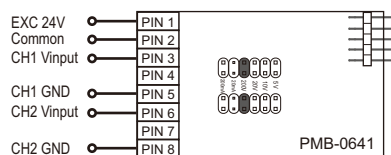

## Single Channel Signal Input Module: (for PB-1471, PB-1470, PB-1570)

01: 4~20mA DC with Excitation +24V

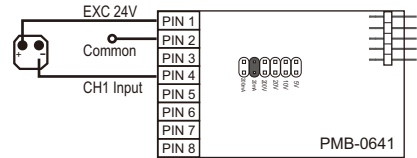

02: 0~20mA DC with Excitation +24V

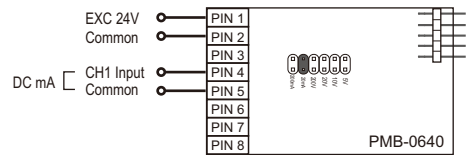

03: 0~200mA DC with Excitation +24V

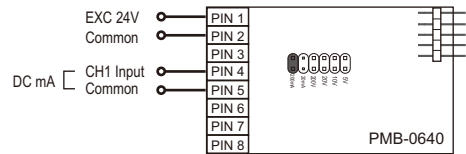

04: ±5V DC with Excitation +24V

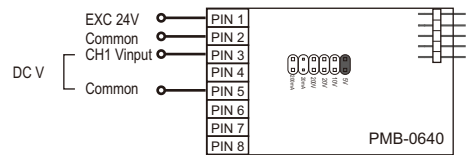

05: ±10V DC with Excitation +24V

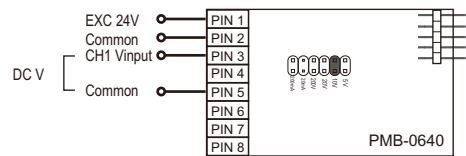

06: ±20V DC with Excitation +24V

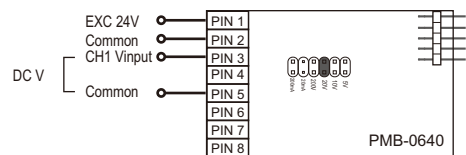

07: ±200V DC with Excitation +24V

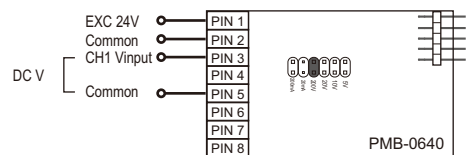

# PB AC SIGNAL INPUT MODULE

This section will elaborate how to adapt to different input signals in the PB series panel meter, by using the correct jumper and using iSEL command. Panel meter series can accommodate 6 types of conventional input signals, 20mA, 200mA, 5V, 10V, 20V, 200V, please refer below for setup.

## Single Channel Signal Input Module: (for PB-1471, PB-1470, PB-1570)

A1: 2mA AC Scaled RMS

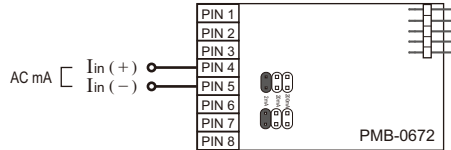

B1: 100mV AC Scaled RMS

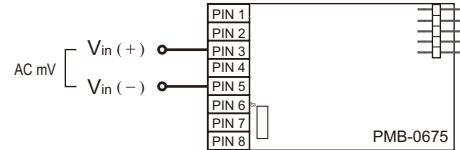

A2: 20mA AC Scaled RMS

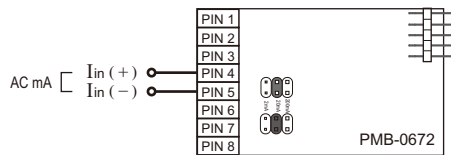

B2: 200mV AC Scaled RMS

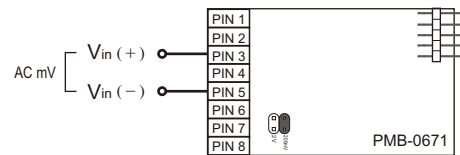

A3: 200mA AC Scaled RMS

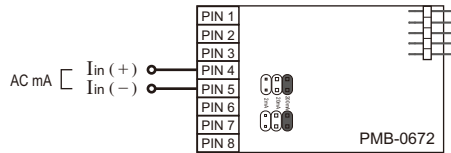

B3: 2V AC Scaled RMS

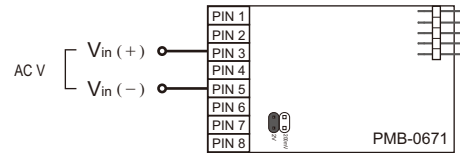

A4: 1Amp AC Scaled RMS

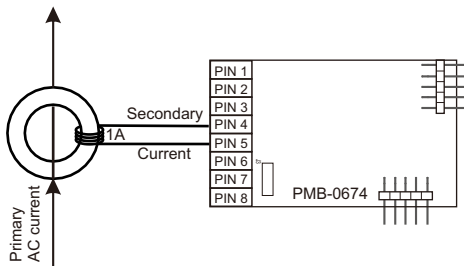

B4: 20V AC Scaled RMS

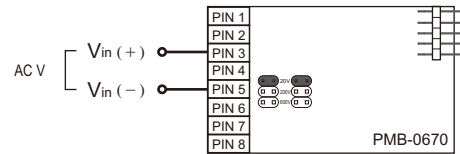

A5: 5 Amp AC Scaled RMS

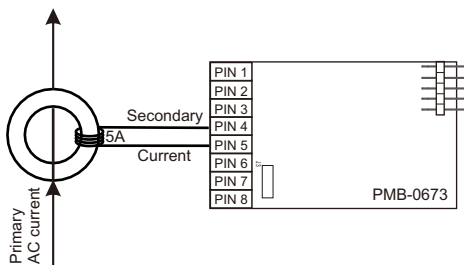

B5: 200V AC Scaled RMS

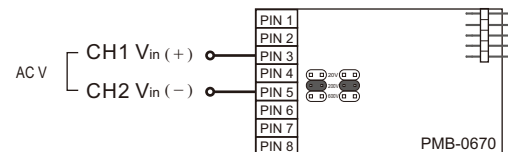

B6: 600V AC Scaled RMS

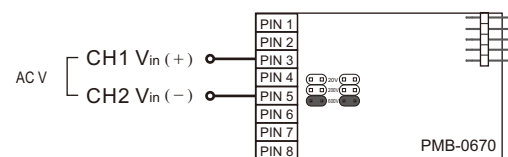

# PB DC SIGNAL INPUT MODULE

This section will elaborate how to adapt to different input signals in the PB series panel meter, by using the correct jumper and using iSEL command. Panel meter series can accommodate 6 types of conventional input signals, 20mA, 200mA, 5V, 10V, 20V, 200V, please refer below for setup.

## Single Channel Signal Input Module: (for PB-1471, PB-1470, PB-1570)

C1: 2mA DC with Excitation +24V

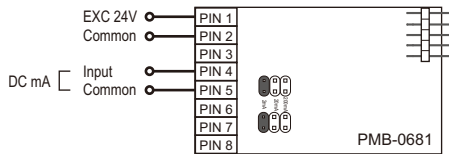

D1: 20 mV DC with Excitation +24V

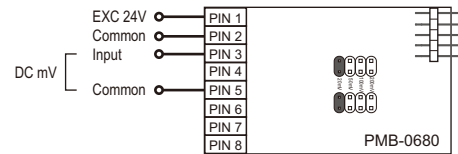

C2: 20mA DC with Excitation +24V

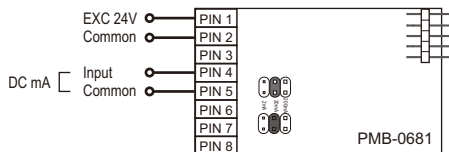

D2: 50 mV DC with Excitation +24V

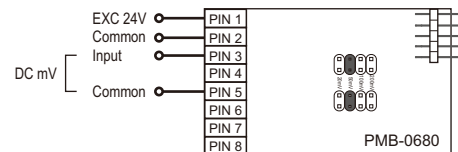

C3: 200mA DC with Excitation +24V

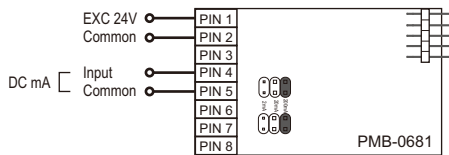

D3: 100 mV DC with Excitation +24V

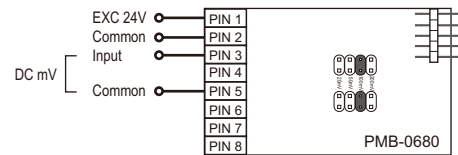

C4: 1A DC

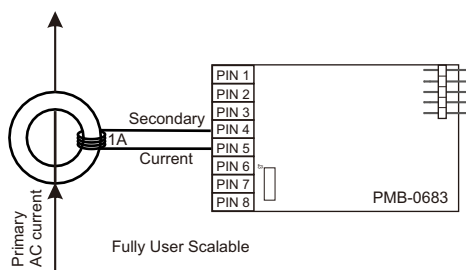

D4: 200 mV DC with Excitation +24V

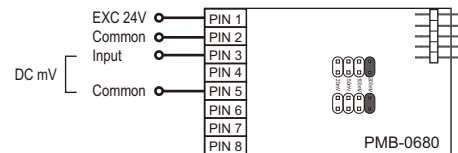

C5: 5A DC

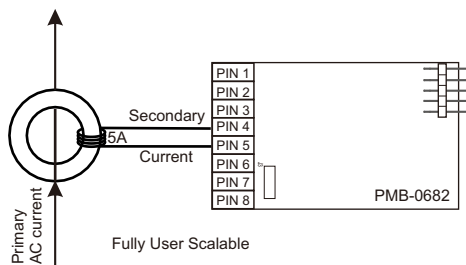

# PM DC SIGNAL INPUT MODULE

This section will elaborate how to adapt to different input signals in the PM series panel meter, by using the correct jumper and using iSEL command. Panel meter series can accommodate 6 types of conventional input signals, 20mA, 200mA, 5V, 10V, 20V, 200V, please refer below for setup.

## Dual Channel Signal Input Module: (for PB-2430)

11: 4~20 mA DC with Excitation +24V

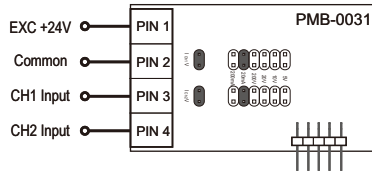

22: 200 mA DC with Excitation +24V

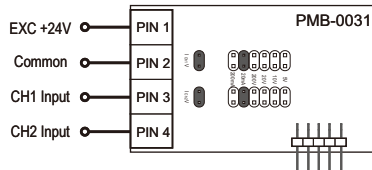

33: 200 mA DC with Excitation +24V

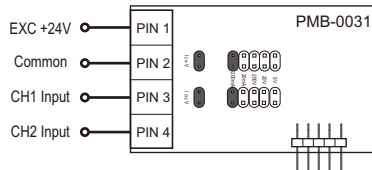

44: 5V DC with Excitation +24V

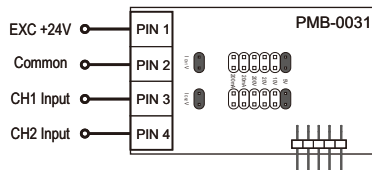

55: 10V DC with Excitation +24V

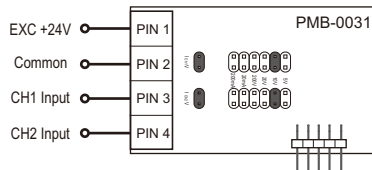

66: 20V DC with Excitation +24V

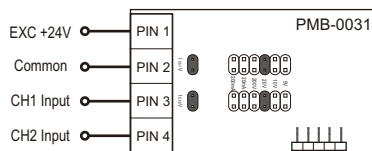

77: 20V DC with Excitation +24V

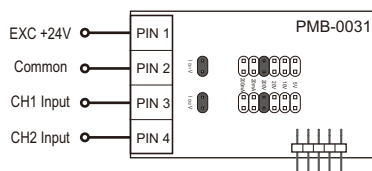

## Single Channel Signal Input Module: (for PB-1430, PB-1530)

01: 4~20mA DC with Excitation +24V

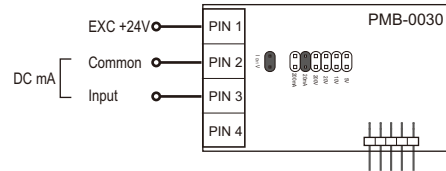

02: 20mA DC with Excitation +24V

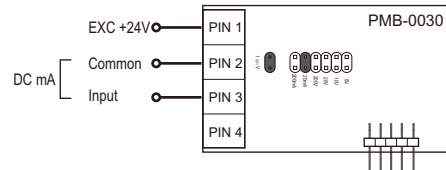

03: 200mA DC with Excitation +24V

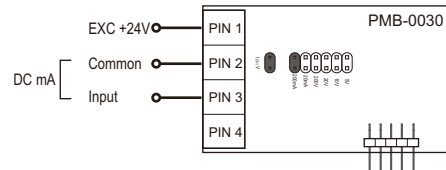

04: 5V DC with Excitation +24V

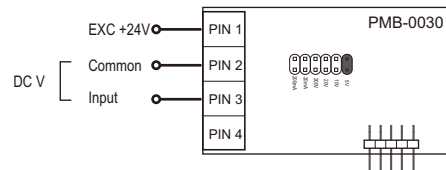

05: 10V DC with Excitation +24V

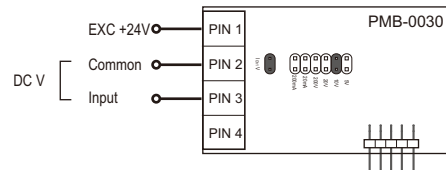

06: 20V DC with Excitation +24V

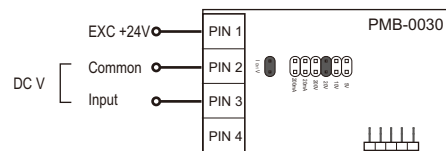

07: 200V DC with Excitation +24V

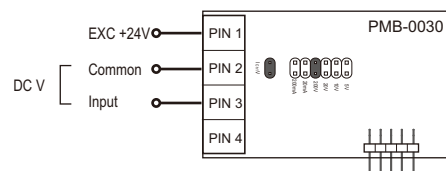

# PM AC SIGNAL INPUT MODULE

This section will elaborate how to adapt to different input signals in the PM series panel meter, by using the correct jumper and using iSEL command. Panel meter series can accommodate 6 types of conventional input signals, 20mA, 200mA, 5V, 10V, 20V, 200V, please refer below for setup.

## Single Channel Signal Input Module: (for PM-1430, PM-1530)

A1: 2mA AC Scaled RMS

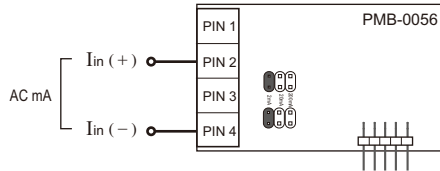

B1: 100mV AC Scaled RMS

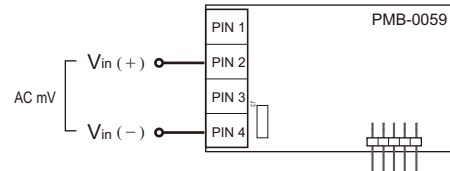

A2: 20mA AC Scaled RMS

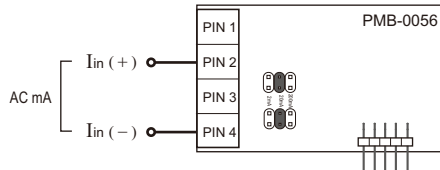

B2: 200mV AC Scaled RMS

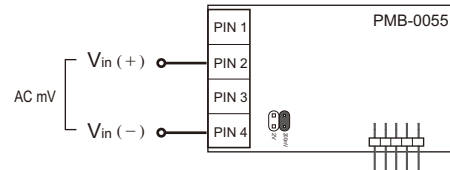

A3: 200mA AC Scaled RMS

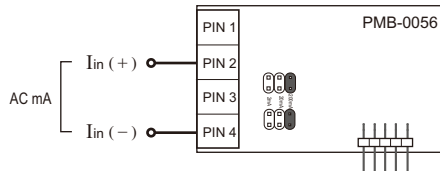

B3: 2V AC Scaled RMS

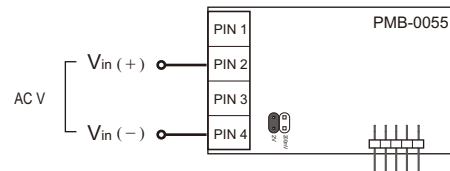

A4: 1Amp AC Scaled RMS

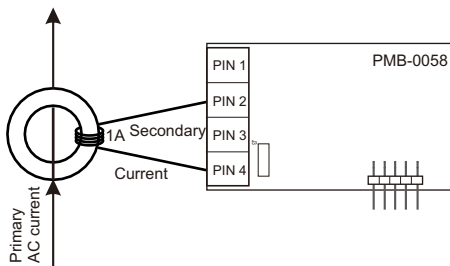

B4: 20V AC Scaled RMS

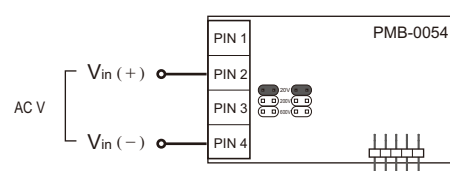

A5: 5 Amp AC Scaled RMS

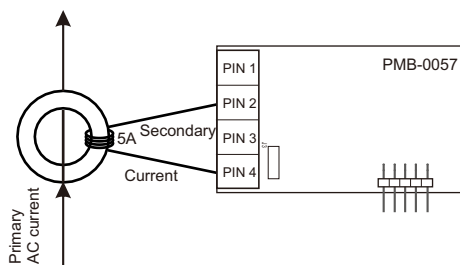

B5: 200V AC Scaled RMS

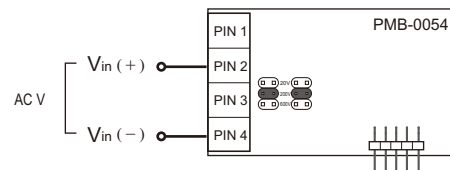

B6: 600V AC Scaled RMS

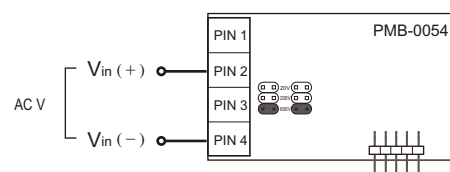

# PM DC SIGNAL INPUT MODULE

This section will elaborate how to adapt to different input signals in the PM series panel meter, by using the correct jumper and using iSEL command. Panel meter series can accommodate 6 types of conventional input signals, 20mA, 200mA, 5V, 10V, 20V, 200V, please refer below for setup.

## Single Channel Signal Input Module: (for PM-1430, PM-1530)

C1: 2mA DC with Excitation +24V

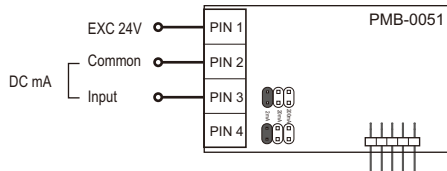

D1: 20 mV DC with Excitation +24V

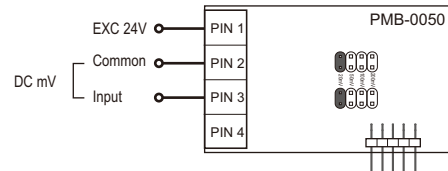

C2: 20mA DC with Excitation +24V

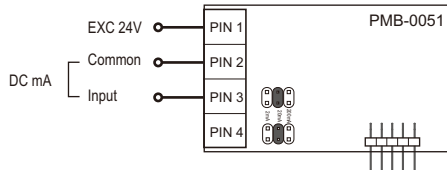

D2: 50 mV DC with Excitation +24V

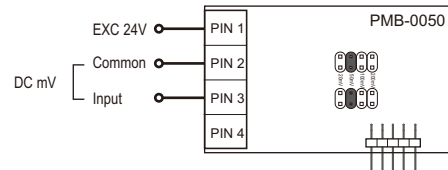

C3: 200mA DC with Excitation +24V

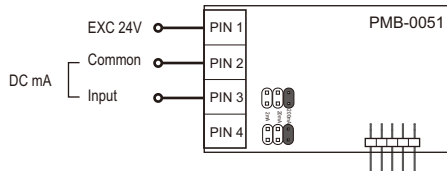

D3: 100 mV DC with Excitation +24V

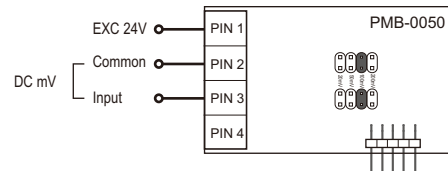

C4: 1A DC

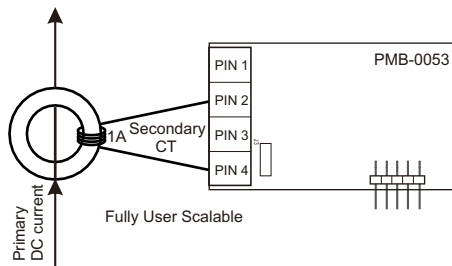

D4: 200 mV DC with Excitation +24V

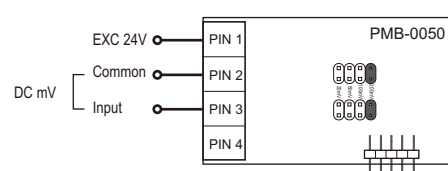

C5: 5A DC

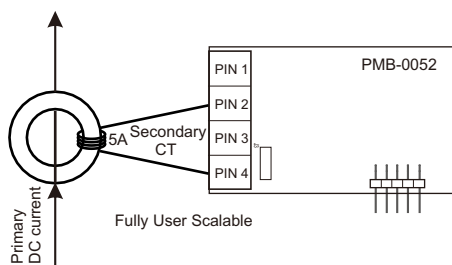

# PM -1X30-W DC SIGNAL INPUT MODULE(0)

This section will elaborate how to adapt to different input signals in the PM series panel meter, by using the correct jumper and using iSEL command. Panel meter series can accommodate 6 types of conventional input signals, 20mA, 200mA, 5V, 10V, 20V, 200V, please refer below for setup.

## Signal Input Module:

01: 4~20mA DC with Excitation +24V

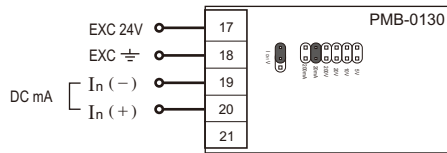

05: 0~10V DC with Excitation +24V

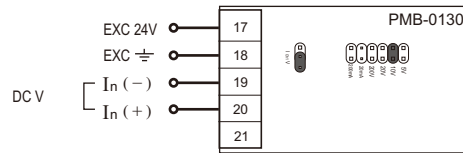

02: 0~20mA DC with Excitation +24V

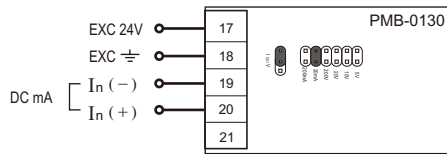

06: 0~20V DC with Excitation +24V

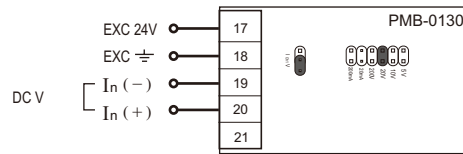

03: 0~200mA DC with Excitation +24V

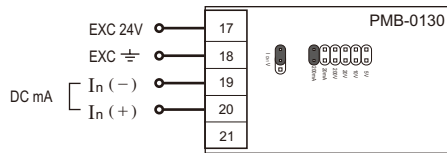

07: 0~200V DC with Excitation +24V

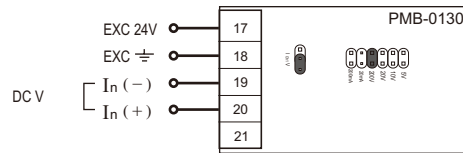

04: 0~5V DC with Excitation +24V

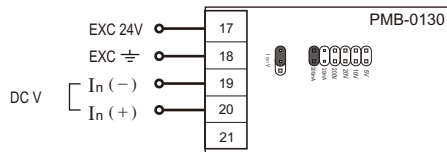

# PM -1X30-W AC SIGNAL INPUT MODULE(AB)

This section will elaborate how to adapt to different input signals in the PM series panel meter, by using the correct jumper and using iSEL command. Panel meter series can accommodate 6 types of conventional input signals, 20mA, 200mA, 5V, 10V, 20V, 200V, please refer below for setup.

## Signal Input Module:

A1: 0~2mA AC RMS

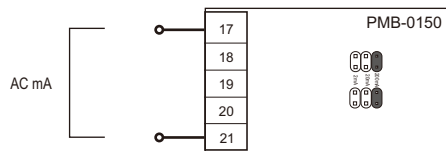

B1: 0~100mV AC RMS

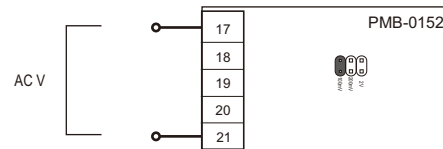

A2: 0~20mA AC RMS

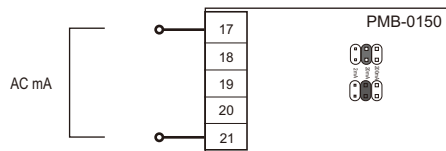

B2: 0~200mV AC RMS

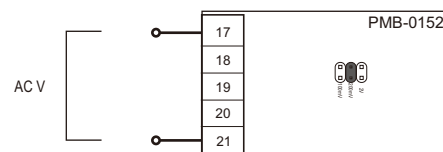

A3: 0~200mA AC RMS

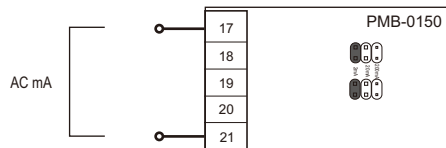

B3: 0~2V AC RMS

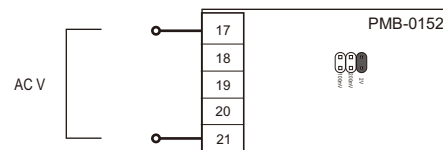

B4: 0~20V AC RMS

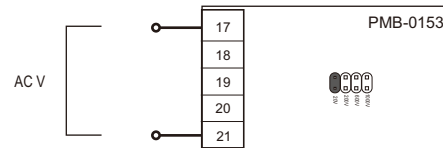

A4: 0~1A AC RMS

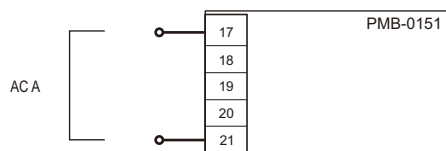

B5: 0~200V AC RMS

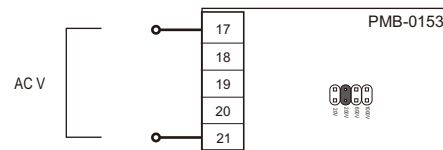

A5: 0~5A AC RMS

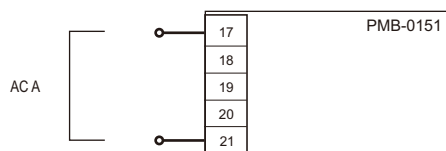

B6: 0~600V AC RMS

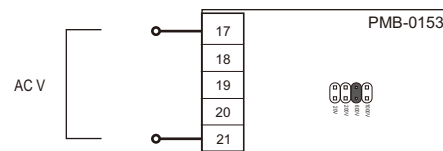

B7: 0~1000V AC RMS

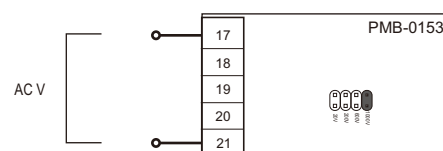

# PM -1X30-W DC SIGNAL INPUT MODULE(CDE)

This section will elaborate how to adapt to different input signals in the PM series panel meter, by using the correct jumper and using iSEL command. Panel meter series can accommodate 6 types of conventional input signals, 20mA, 200mA, 5V, 10V, 20V, 200V, please refer below for setup.

## Signal Input Module:

C1: 0~±2mA DC with Excitation +24V

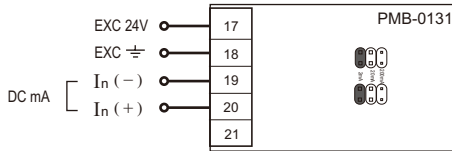

D1: 0~±20mV DC with Excitation +24V

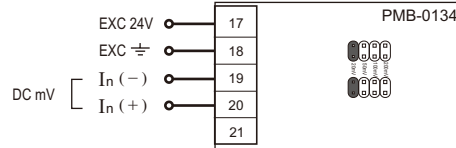

C2: 0~±20mA DC with Excitation +24V

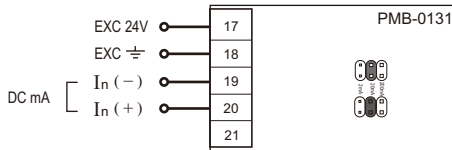

D2: 0~±50mV DC with Excitation +24V

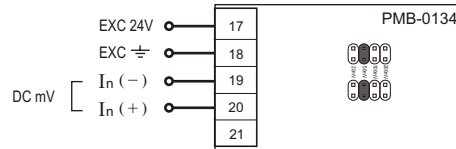

C3: 0~±200mA DC with Excitation +24V

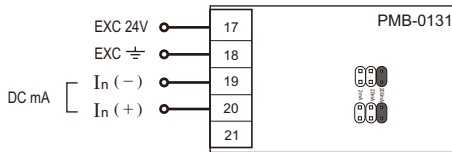

D3: 0~±100mV DC with Excitation +24V

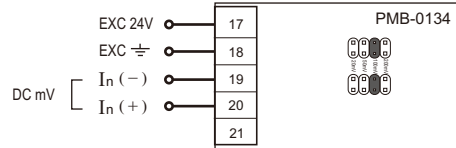

D4: 0~±200mA DC with Excitation +24V

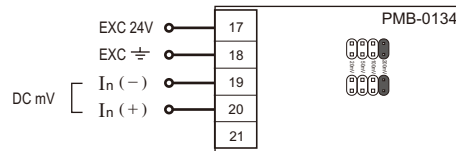

C4: 0~±1A DC

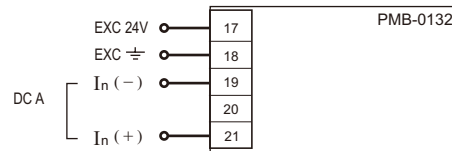

E1: 5/10/20/50/100/200mV DC (Option) with Excitation +24V

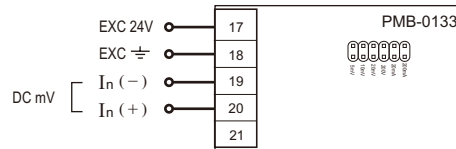

C5: 0~±5A DC

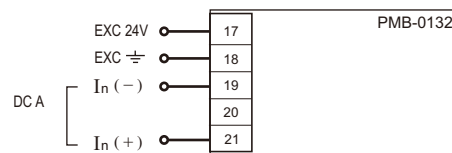

E2: 1/2/5/10/20mV/V (Option) with ISO 10V

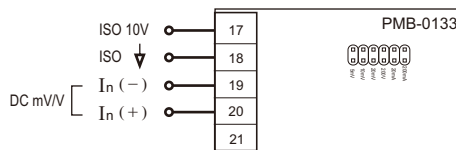

E3: 1/2/10/20/40mV/V (Option) with ISO 5V

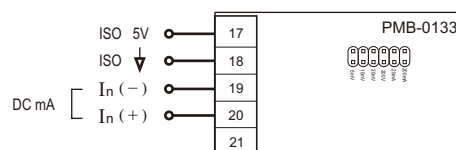

# PM-1X30-W TEMPERATURE SIGNAL INPUT MODULE

This section will elaborate how to adapt to different input signals in the PM series panel meter, by using the correct jumper and using iSEL command. Panel meter series can accommodate 6 types of conventional input signals, 20mA, 200mA, 5V, 10V, 20V, 200V, please refer below for setup.

## Signal Input Module:

F1: TC (K、J、E、N、T) & RTD (Pt100、JPT100)

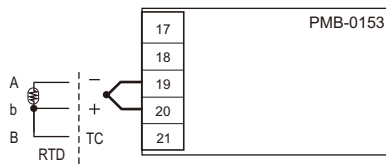

F2: TC (K、J、E、N、T、R、S、B) & RTD (PT100、JPT100)

